



www.oregonchain.com

X-Chain Hydraulic Grinder

620-120

120 V~ 60 Hz

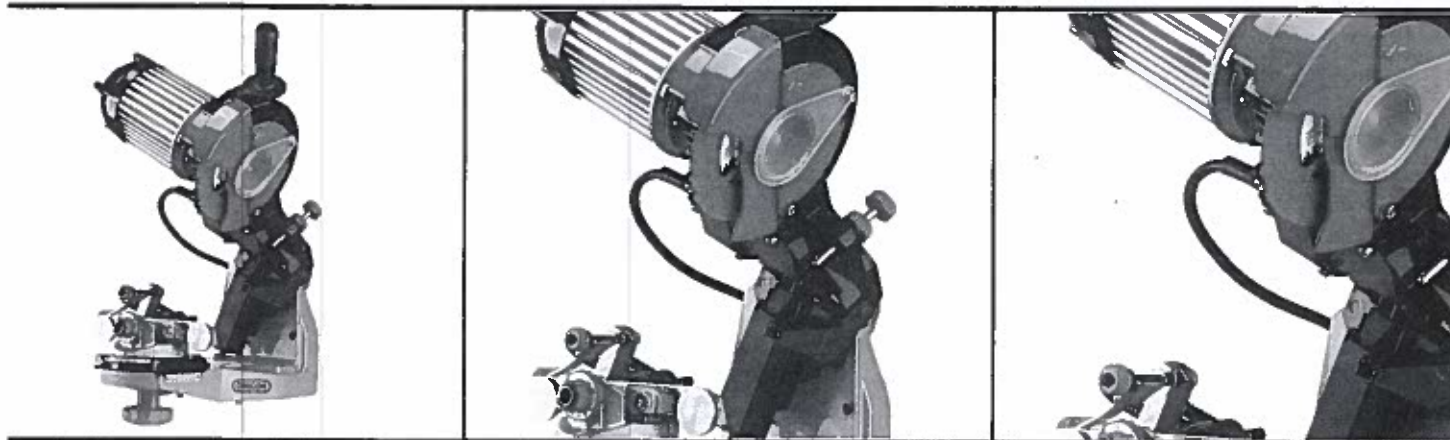

EN 1
Bench chain grinder
OWNER'S MANUAL
Attention: do not use the grinder before you have read the owner's manual in full

FR 6
Meuleuse électrique pour chaînes de scie électrique
MANUEL D'UTILISATION ET ENTRETIEN
Attention : ne pas utiliser l'appareil sans avoir préalablement lu le manuel d'utilisation et entretien

ES 11
Esmerladora eléctrica para cadenas de motosierra
MANUAL DE INSTRUCCIONES
Atención: no utilice la unidad sin haber leído el manual de instrucciones

INTRODUCTION

FOR YOUR OWN SAFETY READ INSTRUCTION MANUAL BEFORE OPERATING GRINDER.

Keep this manual for future reference.

To ensure the correct use of the grinder and to prevent accidents, do not start working without having read this manual carefully.

The manual explains how the various components work and provides instructions for carrying out the necessary checks and maintenance operations.

1. SAFETY RULES AND PRECAUTIONS



! WARNING ! - The use of accessories or attachments not recommended by the manufacturer may result in a risk of injury to persons!

Any maintenance operation not described in this manual must only be carried out by an AUTHORIZED service center.



! CAUTION ! The following instructions should be carefully followed in order to reduce the risk of kick-back resulting from improperly sharpened saw chains.

1 - **USERS.** The grinder must only be used by adults. Users must be in good physical condition and familiar with the instructions for use.

2 - **KEEP CHILDREN AWAY.** All visitors should be kept at safe distance from work area.

3 - **WEAR PROPER APPAREL.** Never wear loose clothing, bracelets, neckties, rings or any other jewelry that could come into contact or get caught with the grinding wheel or any other moving parts. Non slip footwear is recommended. Wear protective hair covering to contain long hair.

4 - **ALWAYS USE SAFETY GLASSES OR FACE SCREEN.** Always wear gloves and protective eyewear while operating the grinder and while retouching the wheel using the dressing stone. Also use face or dust mask if cutting operation is dusty. Everyday eyeglasses only have impact resistant lenses, they are NOT safety glasses.

5 - **NEVER STOP THE WHEEL WITH YOUR HANDS.** Never attempt to stop the rotation of the grinding wheel with your hands.

6 - **DISCONNECT TOOLS** before servicing. Make sure the plug is disconnected when fitting or changing the grinding wheel and during any other operation of maintenance or transport.

7 - **KEEP GUARDS IN PLACE AND IN WORKING ORDER.** Never start the grinder without the wheel guards in place.

8 - **REMOVE ADJUSTING KEYS AND WRENCHES.** Make sure that keys and adjusting wrenches are removed from tool before turning it on.

9 - **DON'T FORCE TOOL.** It will do the job better and safer at the rate for which it was designed. Each grinder has a plate indicating:

- size of arbor: Ø .866" (22 mm)
- no-load speed in revolutions per minute: RPM 3400
- always to read instruction manual before operating the machine
- always to wear eye and face protection
- always use the proper grinding wheel

Also make sure that the voltage and frequency indicated on the plate applied to the grinder correspond to those of the mains hook-up.

10 - **REDUCE THE RISK OF UNINTENTIONAL STARTING.** Always make sure that the start-up switch is in the "0" (OFF) position before connecting the plug to the outlet.

11 - **NEVER USE CABLES, PLUGS OR EXTENSION CABLES THAT ARE DEFECTIVE OR NON-STANDARD.**

12 - **REMOVE THE PLUG** from the mains immediately if the cable is damaged or cut; for cable repair or replacement, contact your authorized dealer or service center. The power supply cable is complete with terminals - with protection. The internal electrical connection consists of inserting the feeding cable terminals directly in the switch. The electrical connection to the mains shall be made in such a way as to prevent damages by peoples or vehicles which could endanger both them and you.

13 - **KEEP WORK AREA CLEAN.** Cluttered areas and benches invite accidents. Make sure that the working area of the grinding wheel is free of tools or other objects before starting up the grinder. Frequently clean grinding dust from beneath grinder.

14 - **DON'T USE IN DANGEROUS ENVIRONMENT.** Don't use power tools in damp or wet locations, or expose them to rain. Keep work area well lighted.

15 - **CHECK THE POSITION OF THE CABLE DURING OPERATION,** making sure that it remains outside the range of action of the grinding wheel and is not under tension. Never operate in the vicinity of other electrical cables

16 - **DIRECTION OF FEED.** Feed work into a blade or cutter against the direction of rotation of the blade or cutter only. Never advance the chain with your left hand until the grinding wheel has moved entirely outside the work area.

17 - **MAKE WORKSHOP KID PROOF** with padlocks, master switches. Do not also allow anybody but the user to remain in the vicinity of the grinder while it is operating or to touch the grinder supply cable.

18 - **ALWAYS KEEP THE HAND-GRIPS CLEAN AND DRY.**

19 - **Before starting the grinder, MAKE SURE THAT THE GRINDING WHEEL IS CORRECTLY SECURED** and outside the work area.

Do not overtighten the wheel nut.

20 - **SECURE WORK.** Make sure that the machine is stably secured, as shown in Figure 1. Use the vise to hold chain. It frees both hands for moving the wheel down to grind the chain.

21 - **DON'T OVERREACH.** Keep proper footing and balance at all times.

22 - **NEVER STAND ON TOOL.** Always work in a stable and safe position. Serious injury could occur if the tool is tipped or if the cutting tool is unintentionally contacted.

23 - **ALWAYS FOLLOW THE INSTRUCTIONS** for maintenance.

24 - **CHECK DAMAGED PARTS.** Before using the grinder, check to make sure that all the devices, those for safety and others, are in good working order. A guard, a wheel or other part that is damaged should be carefully checked to determine that it will operate properly and perform its intended function - check for alignment of moving parts, binding of moving parts, breakage of parts, mounting, and any other conditions that may affect its operation. A guard, a wheel or other part that is damaged should be properly repaired or immediately replaced.

25 - **USE RECOMMENDED ACCESSORIES.** Consult the owner's manual for recommended accessories. The use of improper accessories may cause risk of injury to persons. Use only flanges furnished with the grinder. To guarantee the efficient and consistent operation of your grinder, remember that any worn or broken parts must only be replaced using ORIGINAL SPARE PARTS.

26 - **USE ONLY RECOMMENDED GRINDING WHEELS.**

27 - **CHECK YOUR MACHINE.** Never work with a damaged, poorly repaired, incorrectly fitted, or arbitrarily modified grinder. Do not remove, damage, or disable any safety device.

28 - **USE RIGHT TOOL.** Never use the grinder as a cutter or for grinding objects other than saw chains. Don't force tool or attachment to do a job for which it was not designed. **DO NOT USE** the machine with saw blade disc assembled.

29 - **LEND YOUR GRINDER ONLY TO EXPERT USERS** who are familiar with its operation and correct use, and always give them the instruction manual to read before they start a job.

30 - **MAINTAIN TOOLS WITH CARE.** Keep tools sharp and clean for best and safest performance. Follow instructions for lubricating and changing accessories.

31 - **STORE YOUR GRINDER IN A DRY PLACE,** raised off the ground and out of the reach of children.

32 - **NEVER LET YOUR GRINDER BE EXPOSED TO RAIN OR DAMPNESS.**

33 - **NEVER USE THE GRINDER IN AN EXPLOSIVE OR INFLAMMABLE ATMOSPHERE.**

34 - **TAKE THE GRINDER TO YOUR DEALER.** When your grinder is not in working order, do not abandon it on the work site or elsewhere. Take it to your dealer who will store or dispose of it correctly.

35 - **ALWAYS CONSULT YOUR DEALER** for any clarification or important maintenance or repair operation.

36 - **NEVER JERK THE CABLE TO DISCONNECT IT FROM THE OUTLET.** Keep the cable away from heat, oil, and sharp objects.

37 - **USE PROPER EXTENSION CORD.** Make sure your extension cord is in good condition. When using an extension cord, be sure to use one heavy enough to carry the current your product will draw. An undersized cord will cause a drop in line voltage resulting in loss of power and overheating. Table 1 shows the correct size to use depending on cord length and nameplate ampere rating. If in doubt, use the next heavier gage. The smaller the gage number, the heavier the cord.

Table 1 - Minimum gauge for cord

Ampere Rating		Volts	Total length of cord in feet
		120 V~	25 ft.
More Than	Not More Than	Gauge needed	
0	6	18	



! CAUTION - SETTING UP THE GRINDER

The grinder must only be used in a place that is protected from dust and dampness, that is well-lighted, out of the reach of children, and away from gasses or other inflammable or explosive liquids.
The grinder must be situated near a normal electrical outlet equipped with earth (grounded). **Avoid using dangerous extension cables.

**GROUNDING INSTRUCTIONS.

A. In the event of malfunction or breakdown, grounding provides a path of least resistance for electric current to reduce the risk of electric shock. This tool is equipped with an electric cord having an equipment-grounding conductor and a grounding plug. The plug must be plugged into a matching outlet that is properly installed and grounded in accordance with all local codes and ordinances.
Do not modify the plug provided - if it will not fit the outlet, have the proper outlet installed by a qualified electrician.

Improper connection of the equipment-grounding conductor can result in a risk of electric shock. The conductor with insulation having an outer surface that is green with or without yellow stripes is the equipment-grounding conductor. If repair or replacement of the electric cord or plug is necessary, do not connect the equipment-grounding conductor to a live terminal.

Check with a qualified electrician or service personnel if the grounding instructions are not completely understood, or if in doubt as to whether the tool is properly grounded. Use only 3-wire extension cords that have 3-prong grounding plugs and 3-pole receptacles that accept the tool's plug. Repair or replace damaged or worn cord immediately.

B. Grounded, cord-connected tools intended for use on a supply circuit having a nominal rating less than 150V~. This tool is intended for use on circuit that has an outlet that looks like the one illustrated in sketch A in figure. The tool has a grounding plug that looks like the plug illustrated in sketch A in figure. A temporary adapter, which looks like the adapter illustrated in sketches B and C, may be used to connect this plug to a 2-pole receptacle as shown in sketch B if a properly grounded outlet is not available. The temporary adapter should be used only until a properly grounded outlet can be installed by a qualified electrician. The green-colored rigid ear, lug, and the like, extending from the adapter must be connected to a permanent ground such as a properly grounded outlet box.

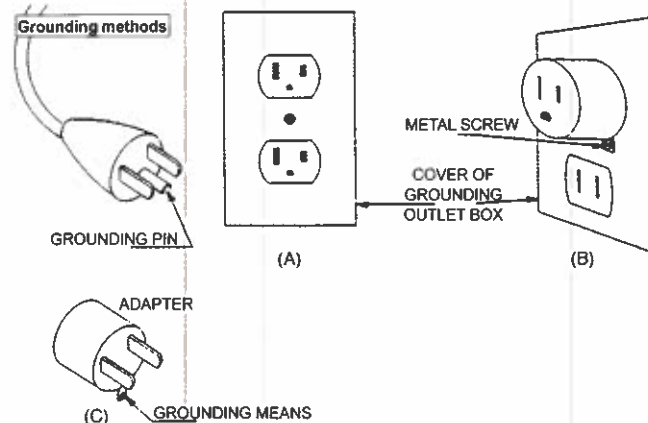

2. GENERAL INFORMATION

The manufacturer is not liable for damages in the following cases:

- failed observance of the instructions given herein;
- use of the appliance other than that described in the "INTENDED USE" section;
- failed use in compliance with current standards on Health & Safety at the workplace;
- Incorrect installation;
- lack of scheduled maintenance;
- modifications or jobs that are not authorized by the manufacturer;
- use of non-original or inadequate spare parts;
- repairs that are not carried out by a specialist.

3. WARRANTY

The warranty validity is that acknowledged in the country of sale. Claims under warranty will only be accepted if they are backed-up by the copy of the purchase document (bill or receipt).

The guarantee becomes void if:

- a) the appliance has been tampered with;
- b) the appliance has not been used according to this manual;
- c) non-original parts, appliances or grinding wheels have been fitted on the grinder or other parts that are not authorized by the manufacturer;
- d) the appliance has been powered at a voltage or frequency different from that written in the rating nameplate.

4. USING AND KEEPING UP THE OWNER'S MANUAL

The characteristics and the information given in this manual are merely indicative. The manufacturer reserves the right to add any modifications to the grinder considered necessary at any time.

It is forbidden to reproduce any part of this document without authorization on behalf of the manufacturer.

The owner's manual is integral part of the appliance and must be kept in a safe place so that it can be consulted whenever need be.

If you should lose your manual or it should deteriorate, you can request your dealer or an authorized service centre for another copy.

The manual shall accompany the appliance at all times, especially if it is sold on at a later date.

5. DEFINITIONS

Skilled technician: a person who is generally employed by the service centre and who is trained to carry out extraordinary maintenance jobs and repairs on the appliance.

6. SYMBOLS

	This symbol points out the possibility of serious personal injuries if the provisions and instructions are not complied with.
	This symbol points out that the user must wear protection goggles when he uses the appliance.
	This symbol points out that the user must wear protective gloves when he uses the appliance.
	This symbol points out the correct running direction of the appliance (grinding wheel).

7. TECHNICAL DATA

Model	X-Chain Hydraulic Grinder
Voltage	120V~ 60Hz
Rated power	300W
Grinding wheel dimensions	Outside Ø 145 mm - Inside Ø 22.2 mm Thickness: 3,2 - 4,7 - 8,0 mm
Maximum speed of grinding wheel	3400 min ⁻¹
Max. power of lamp	15W
Acoustic pressure level	79 dB(A)
Level of vibrations on operating handle	< 2,5 m/s ²
Types of chains that can be sharpened	1/4" - .325" - 3/8" - .404" - 3/4"
Weight (complete machine)	7,7 kg

8. PART DESCRIPTION (FIG.1)

- | | |
|---------------------------------------|--------------------------------------|
| 1 Base unit | 11 Arm operating handle |
| 2 Arm-motor unit | 12 Shield guard |
| 3 Vise assembly | 13 Supplementary plastic arbor guard |
| 4 Chain gauge setting knob | 14 Grinding wheel |
| 5 Vise adjustment knob | 15 Sharpening depth setting knob |
| 6 Chain jaws | 17 Lamp |
| 7 Chain blocking unit adjustment knob | 18 Main ON/OFF switch |
| 8 Chain blocking unit adjustment knob | 19 Electrical power cable |
| 9 Chain blocking unit | 20 Rating nameplate |
| 10 Arm blocking handle | |

9. SAFETY DEVICES

The grinder is equipped with the safety devices illustrated hereafter:

- **Shield guards:** they protect the operator from parts of the grinding wheel that may come away during the sharpening process.
These guards must always be fitted in place when the appliance is in use.
Always make sure the guards are efficient and fitted properly. Operator safety could be compromised if the guards are damaged and/or cracked.
- **Switch:** the appliance features a safety switch with release coil. In the case of a sudden power failure, the switch trips automatically and disconnects the appliance from the mains. The appliance will not start even if the power supply is suddenly restored. You need to reset the switch to start the appliance again.

10. INTENDED USE

This appliance is an electrical grinder for chains used in chain saws.

- Use the appliance exclusively for the types of chains stated in the technical data chart.
- Do not use the appliance to cut or grind anything other than the chains envisaged.
- Secure the appliance firmly to the bench or wall.
- The appliance must not be used in corrosive or explosive environments.
- **Any other use is to be considered improper.**

The manufacturer is not liable for damages following improper or incorrect use of the appliance.

11. UNPACKING

The grinder is supplied already completely assembled.

12. STANDARD SUPPLY (FIG.2)

- | | |
|-----------------------------------|---------------------------------|
| 1 - Grinder base unit | 9 - Dressing brick |
| 2 - Instruction manual | 10 - 4 mm Allen wrench |
| 3 - Test card | 11 - 5 mm Allen wrench |
| 4 - Grinding wheel Ø 145x3.2x22.2 | 12 - M8x80 screw |
| 5 - Grinding wheel Ø 145x4.7x22.2 | 13 - M8 nut |
| 6 - Grinding wheel Ø 145x8x22.2 | 14 - Washer for M8 screw |
| 7 - Operating handle | 15 - Sharpening template ~ 3/4" |
| 8 - Sharpening template | 16 - Chain stop kit - 3/4" |

13. TESTING THE GRINDING WHEEL

Hold the grinding wheel up by its central hole. Knock the edge of the grinding wheel (fig. 3) gently with a non-metallic object. If it makes a numb non-metallic noise it means that the wheel could be damaged: do NOT use it!

14. INSTALLATION

ATTENTION

Do not install the appliance at eye level. You are recommended to install it at a height of no more than 1.2-1.3 meters off the floor. The appliance can be bench mounted or wall mounted.

14.1 BENCH MOUNTING (FIG.4)

Use 2 M8 screws complete with washers and nuts (material supplied), inserted in the securing holes F4. Make sure you position the base unit on the bench as illustrated in the detail.

14.2 WALL MOUNTING (FIG.5)

Use two dowels with relative screws complete with washers (material not supplied), inserted in the securing holes F6.

14.3 SECURING THE OPERATING HANDLE (FIG.6)

Completely screw the operating handle I7 on the screw V7.

15. CHAIN INFORMATION

The chain must be completely inspected before sharpening it to make sure it is intact.

(fig. 7) Cutter parts:	(fig. 8) Chain parts:
1 Top part	1 Connection link
2 Top cutting angle	2 Left cutter
3 Side cutting angle	3 Right cutter
4 Sharpening recess	4 Driving link (pulling link)
5 Depth gauge	5 Rivet
6 Bit	
7 Heel	
8 Rivet hole	

16. CHAIN IDENTIFICATION

- Before you start to sharpen, you need to know the type of chain and the relative adjustment angles. These characteristics are written in the owner's manual of the chain saw on which the chain is fitted or on the chain pack.
 - The chain identification code is usually written on the driving link.
 - You can also identify the chain using a template or gauge.
 - Consult the CHAIN CHART at the end of this manual.
- The columns in this chart provide the following information:

	Wheel Width
	Vise Rotate Angle
	Down Angle
	Head Tilt Angle
	Depth Gauge

16.1 INSTRUMENTAL MEASUREMENTS (FIG.9)

- a - Measure the gauge depth using the suitable shape.
- b - Put the template on this side and measure the chain PITCH.
- c - Put the template on this side to measure the cutter length.
- d - The driving link width is measured using a suitable instrument (i.e. gauge).

17. GRINDING WHEEL WARNINGS

- Use a grinding wheel suitable for the type of chain to be sharpened; consult the chain chart at the end of the manual.
- Do not force the grinding wheel on the hub and do not alter the centering hole diameter. Do not use grinding wheels that do not fit perfectly in place.
- Use exclusively clean and perfect intact hub and flange to fit the grinding wheel.
- Make sure the outside diameters of the hub and flange are identical.

18. FITTING THE GRINDING WHEEL

- Loosen the screw V10 and turn the guard P10 (fig. 10)
- Remove the screw V8 and the flange F8 on the hub (fig.11)
- Choose the grinding wheel based on the type of chain to be sharpened (column H in chain chart).
- Insert and perfectly center the grinding wheel in the dedicated seat on the hub (fig.12-13).
- Insert the flange F8 and tighten the screw V8 (fig.12).

Make sure you fit the flange as illustrated in fig.13.
 If the grinding wheel is fitted with the flanges too tight, it could break during use and put the operator at risk. To avoid such risk, tighten screw M6x25 to 7 Nm (if possible, check with dynamometric spanner).

- Close the guard again P10 and tighten the relative screw V10 (fig.14).

18.1 REPLACING THE CHAIN STOP KIT (FOR 3/4" CHAINS)

- The special chain stop kit must be fitted for 3/4" chains only.
- Loosen and unscrew the knob P14 (fig. 14A).
- Remove the chain stop kit K1 (fig. 14B).
- Fit the 3/4" chain stop kit K2 (fig. 14C and 14D).
- Screw up and tighten the knob P15 (fig. 14E).

19. CHECKING THE ASSEMBLY OF THE GRINDING WHEEL

- Stand at the side of the grinding wheel, start the grinder and visually make sure the grinding wheel does not oscillate sideways or crosswise, consequently causing abnormal vibrations.
- If this should be the case, stop the appliance immediately and check if the grinding wheel has been fitted correctly. If necessary, replace the grinding wheel with another original one.

Always check a freshly fitted grinding wheel at working speed for at least one minute before you start grinding, standing at a safe distance and making sure nobody else approaches the appliance.

20. ELECTRICAL CONNECTION

- Make sure the electrical system power supply complies with the values written on the rating nameplate.
- The power supply voltage must not differ from that written on the nameplate by ±5%.
- The connection to the electric mains must be prepared subject to current standards in force in the country in which the appliance is used.
- The power socket used for the appliance must have an earth wire, adequate fuse and must be protected by a differential circuit breaker with tripping sensitivity no higher than 30 mA.

21. START-UP

- Plug the power cable into the mains.

22. CHECKING THE GRINDING WHEEL SHAPE

- With the appliance turned off, check the grinding wheel profile using the dedicated template (fig.15); if necessary, dress the wheel to restore the correct profile.

23. GRINDING WHEEL DRESSING

Wear personal protection equipment.

- Start the grinder by turning the switch to position "1".
- Once started, the lamp lights up to illuminate the sharpening area.
- Profile the grinding wheel with the dressing brick, always working with extreme caution, holding it firmly and securely (fig.16).
- Stop the appliance and check if the profile is correct using the template (fig.17).

Contact with the grinding wheel while it spins at high speed may cause burning and abrasions.

24. ADJUSTING THE GRINDER

24.1 SHARPENING ANGLES

- Once you have established the type of chain to be sharpened, look-up the adjustment angles (vise and arm) in the chain chart (columns A/B/C).

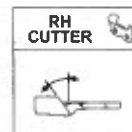

24.2 SETTING THE TOP SHARPENING ANGLE (FIG.18-19)

- Loosen the knob M20.
- Turn the vise clockwise.
- Position the reference mark on the vise by the desired angle.
- Tighten knob M20 again.

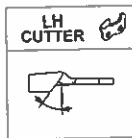

24.3 SETTING THE TOP SHARPENING ANGLE (FIG.18-20)

- Loosen the knob M20.
- Turn the vise counter clockwise.
- Position the reference mark on the vise by the desired angle.
- Tighten knob M20 again.



24.4 SETTING THE CUTTING ANGLE (FIG.21) (right and left cutters)

- Loosen the knob at the back M23 and turn the arm towards the right. Position the reference mark by the angle desired.
- Tighten knob M23 again.

24.5 SHARPENING ANGLES FOR CHAINS WITH "DOWN ANGLE"

- Find the setting angles as just illustrated.
- Set another sharpening position: the down angle. To find out which chains require this setting, consult column E in the chain chart.

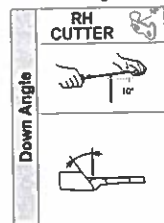

24.6 SETTING THE DOWN ANGLE (FIG.22)

- Loosen knob M20.
- Move the vise towards the operator until the reference mark matches the relevant value on the scale (see chain table).

24.7 SETTING THE TOP SHARPENING ANGLE (FIG.23)

- Turn the vise clockwise.
- Position the reference mark of the vise by the desired angle.
- Tighten knob M20 again.

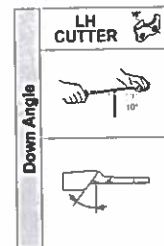

24.8 SETTING THE DOWN ANGLE (FIG.24)

- Loosen knob M20.
- Move the vise towards the opposite side of the operator until the reference mark matches the relevant value on the scale (see chain table).

24.9 SETTING THE TOP SHARPENING ANGLE (FIG.25)

- Turn the vise counter clockwise.
- Position the reference mark of the vise by the angle desired.
- Tighten knob M20 again.



24.10 SETTING THE CUTTING ANGLE (FIG.21) (right and left cutters)

- Loosen the handle at the back M23 and turn the arm towards the right. Position the reference mark on the angle desired.
- Tighten knob M23 again.

24.11 SETTING THE CHAIN BLOCKING UNIT (FIG.26)

- Find the gauge of the drive link
- Turn selector S1 so that the reference mark matches the relevant gauge of the drive link with reference S2 on the vise
- All the gauges of chains presently commercialized are indicated on selector S1
- Put the chain in the vise.
- Take the cutter up against the chain blocking device A29.
- Turn the knob P29 to position the blocking unit A29 correctly compared to the cutter.

24.12 POSITIONING THE CUTTER

- **FOREWORD** When you lower the arm, the chain blocking system is hydraulically operated. In the following adjustment phases, raise the arm whenever you work on the chain positioning knob.
- Take the grinding wheel onto the cutter to be sharpened, pulling the arm downwards. The chain will be blocked.
- Raise the arm so that the chain runs freely.
- Turn the knob P30 to move the chain so that the cutter cutting edge skims the grinding wheel (fig.27).
- At this stage, raise the arm and screw the knob P30 to move the cutter to be sharpened further forwards.

This forward movement corresponds to the quantity of material to be ground from the cutter.

Blunter the cutters, greater must be this forward movement. Vice versa, for cutters that are not too blunt, simply grind just a slight amount of material.

- Turn knob P31 to adjust the cutter sharpening depth. The grinding wheel should skim the bottom of the cutter vertically (fig.28).

25. SHARPENING WARNINGS



- Wear personal protection equipment when sharpening.



- All adjustments must be made with the motor switched off and the grinding wheel **completely stopped**.
- In the case of accidental impact or collision of the wheel during the sharpening process, follow the instructions given in the "GRINDING WHEEL WARNINGS" section.

- Clean the chain before sharpening it.
- To avoid overloading the motor excessively and to avoid damaging the chain cutters, grind minimum quantities of material and do not stop along the same cutter as this could burn the cutting edge.
- Sharpen all the cutters on the same side and then adjust the vise as explained in the previous sections, then sharpen the cutters on the opposite side.
- Do not use cooling liquids during the sharpening process.

26. SHARPENING THE CHAIN

- The vise closes automatically during this procedure and the chain is blocked.
- Turn the appliance on using the switch, press button I33 to release the arm and sharpen the cutter by lowering the arm-motor unit (fig.29).
- Once you have sharpened the chain, raise the arm.
- Run the chain forward to position the next cutter to be sharpened, making sure the cutter rests on the chain stop.
- Lower the arm again to start sharpening.

28. GRINDING WHEEL DRESSING FOR SHARPENING THE DEPTH GAUGE

- Fit the 8 mm thick grinding wheel (fig.30), following the instructions given in points 13-17-18-19.
- Turn the vise so that the reference mark is on position 0 (fig.31).
- Turn the arm to take the reference mark to 55°/60° (fig.31).
- Position the dressing brick on the jaws and against the chain blocking unit (fig.31).



- Hold the dressing brick firmly with one hand (being careful not to touch the grinding wheel).

- Profile the grinding wheel by activating the appliance and grind the grinding wheel until you obtain a profile like the one illustrated in fig.31.
- Switch the appliance off once you have finished.

29. SHARPENING THE DEPTH GAUGE

- Remove the dressing brick and put the chain in the vise.
- Center the cutter compared to the grinding wheel by turning the knobs (P29 and P30).
- Keeping the arm tilted, adjust the grinding depth on the gauge by turning knob P31 (fig.32).
- Sharpen the gauge following the instructions given in the "SHARPENING" section. For this type of sharpening procedure, there is no difference between the right and left cutters, therefore sharpen all the gauges one after the other.
- Check if the gauge depth is correct, using the template with the shape related to the type of chain used (fig.33). Please also consult the chain table, column F.

30. STOPPING AND SHUTTING DOWN

30.1 STOPPING

Turn the appliance off by turning the switch to position "0" and unplug the power cable from the mains.

30.2 SHUTTING DOWN

Once you have finished using the appliance, disconnect it and clean it thoroughly. Store it in a dry and safe place, protected against dust and damp.

30.3 ROUTINE MAINTENANCE

 Follow the instructions given in the "STOPPING" section before you start to work on the appliance.

Maintenance interval	Job
When the grinding wheel reaches a minimum diameter of approximately 105 mm	Replace the grinding wheel.
40 hours	Clean the lamp carefully using a rag or a cleaning brush. Do not use compressed air.
	Clean the grinder carefully using a rag or a cleaning brush. Clean the electric motor and the sliding guides with caution. Do not use compressed air.
40 hours	Make sure all the screws of the hydraulic circuit are tight.
Top-up with oil	When necessary. The grinder is supplied with the hydraulic vise completely operational and with the piston already filled with AGIP OSO 46 (ISO L-HM-VG46/DIN-31524) oil. On a periodic basis you must top-up the oil in the hydraulic circuit. Proceed as follows (fig.34-35-36): a) raise the arm right up. b) unscrew the screw (1) on the fitting secured directly on the piston c) keeping the arm right up, put enough hydraulic oil in the circuit for the grinder to work efficiently (6cc). You are recommended to use a syringe filled with AGIP OSO46 (ISO L-HM-VG46/DIN-31524) oil; d) screw the screw back on and the copper washer without tightening; e) lower the arm slowly to release air from the circuit; f) tighten the screw with the arm right down.

30.4 HANDLING AND TRANSPORT

- If you need to transport the appliance, take it off the bench or wall, dismantle the grinding wheel and put all the parts in a packing box to protect them against impact.

30.5 DEMOLITION AND DISPOSAL

The appliance is to be demolished by qualified personnel in compliance with current laws in force in the country in which it is installed.

The symbol  (on the rating nameplate) points out that the product must not be disposed of with normal household garbage. Contact an authorized tip or your dealer for disposal instructions.

 Before you scrap the machine, make it unusable by cutting the power supply cable for example and make the parts safe, which could cause a source of danger for children if they should play with the machine.

31. TROUBLE SHOOTING

 Follow the instructions given in the "STOPPING" section before you start to work on the appliance.

Problem	Probable cause	Solution
The appliance fails to start when you switch on (main switch in pos. "1").	One of the safety devices of the system to which the appliance is connected has tripped (fuse, circuit breaker etc.)	Reset the safety device. If the safety switch trips again, do not use the appliance, but contact a Skilled technician .
	The appliance is not plugged into the mains properly.	Unplug and plug in again properly.
The lamp fails to switch on when the main switch is turned to position "1".	The lamp is not screwed properly into its seat.	Screw the lamp in place properly.
	The lamp has blown.	Replace the lamp.
The appliance vibrates abnormally.	The grinder is not secured correctly.	Check its attachment and, if necessary, tighten the securing screws correctly.
	The arm-motor unit is not secured correctly to the base unit.	Tighten the related blocking handle correctly.
	The vise assembly is not secured correctly to the base unit.	Tighten the related blocking handle correctly.
The chain fails to block when the motor arm is lowered	The grinding wheel is not fitted correctly in its seat on the hub.	Dismantle the grinding wheel, check its integrity and fit again correctly.
	The chain gauge setting knob is not positioned correctly.	Check the gauge of the drive link and position the setting knob correctly
Oil leaks from hydraulic circuit	Insufficient oil in hydraulic circuit	Top-up with oil following the instructions given in the "Routine maintenance" section.
	Hydraulic hose connection screws loose	Tighten screws

- Contact a **skilled technician** if you are still unable to restore the correct operation of the appliance following the instructions given in the chart.

GRINDING ANGLES CHART

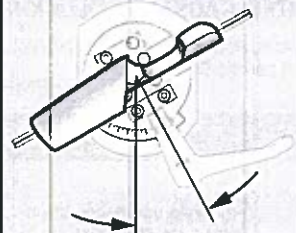
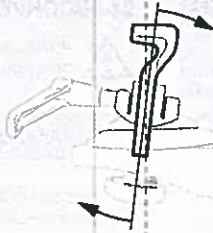
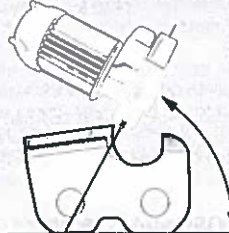
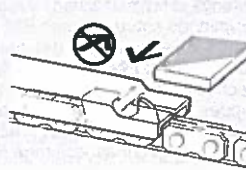
<p>←X→</p> <p>Wheel Width</p> <p><i>Largeur de la meule</i></p> <p>Anchura del disco</p>	<p>A</p> <p>Vise Rotate Angle</p> <p><i>Angle de rotation de l'étau</i></p> <p>Ángulo de rotación del tornillo de banco</p>	<p>B</p> <p>Down Angle</p> <p><i>Angle vers le bas</i></p> <p>Ángulo descendente</p>	<p>C</p> <p>Head Tilt Angle</p> <p><i>Angle d'inclinaison de la tête</i></p> <p>Ángulo de inclinación del cabezal</p>	<p>D</p> <p>Depth Gauge</p> <p><i>Limiteur de profondeur</i></p> <p>Calibre de profundidad</p>
				

		X	A	B	C	D
MICRO CHISEL®	20-21-22BPX 20-21-22P	3/16"	30°	10°	55°	.025" .65 mm
	25AP, 25A, 25F	1/8"	30°	0°	55°	.025" .65 mm
	27A, 27AX	3/16"	30°	10°	55°	.030" .75 mm
	95VPX Ⓢ	3/16"	30°	10°	55°	.025" .65 mm
ROUND GROUND CHISEL	20-21-22LPX M20-21-22LPX	3/16"	25°	10°	55°	.025" .65 mm
	58, 59L, J	3/16"	25°	10°	55°	.025" .65 mm
	68JX, LX	3/16"	25°	10°	55°	.030" .75 mm
	72-73-75JGX, JPX, LGX, LPX, M72-73-75LPX	3/16"	25°	10°	55°	.025" .65 mm
	72-73-75V	3/16"	25°	10°	55°	.025" .65 mm
SEMI-CHISEL	72APX/72-73-75DPX	3/16"	35°	10°	55°	.025" .65 mm
	91PXL, 91VXL, M91VLX	1/8"	30°	0°	55°	.025" .65 mm
RIPPING CHAIN	27R, RA	3/16"	10°	10°	50°	.030" .75 mm
	72-73-75RD	3/16"	10°	10°	50°	.025" .65 mm
CHAMFER CHISEL™	90PX, 90S, 90SG Ⓢ	1/8"	30°	0°	55°	.025" .65 mm
	91P, 91PX, 91VG, 91VX, M91VX	1/8"	30°	0°	55°	.025" .65 mm

Replacement Parts for the 620-120 Bench Grinder

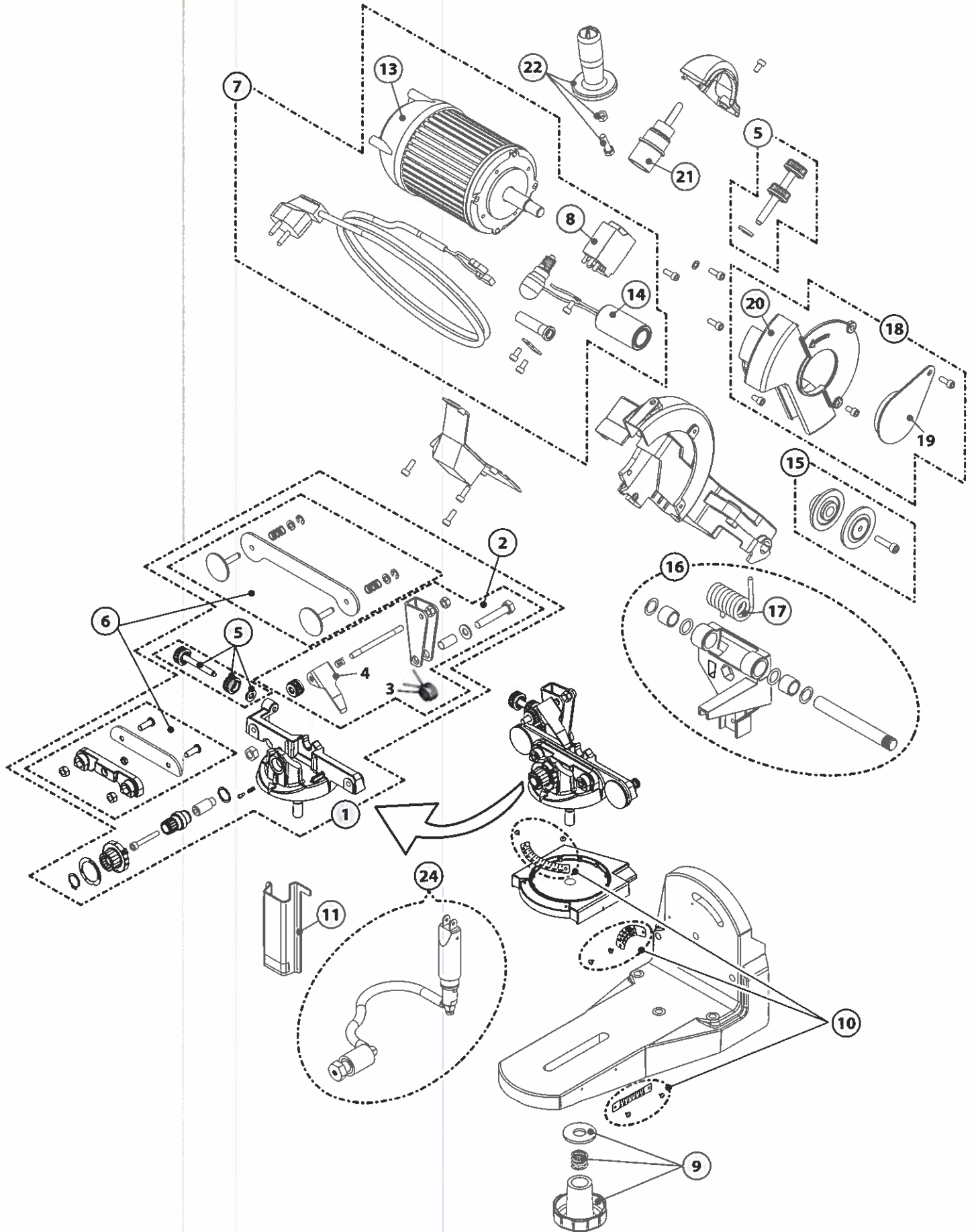

Replacement Parts for the 620-120 Bench Grinder

Ref.	OCS P/N	Description
1	546949	WISE SUPPORT
2	537411	WISE ADJUST. SPRING
	546945	WISE ADJUST. SPRING - MAX. 3/4"
3	35606	CHAIN STOP SPRING
4	546948	LONGER PAWL
5	537412	ADJUSTMENT KNOBS, KIT
6	546947	COMPLETE WISE KIT
7	537398	E-MOTOR, CAPACITOR, SWITCH, CABLES KIT - 120V
8	109879	SWITCH 115 V AC (NEW TYPE)
9	537413	WISE LOCKING KIT
10	537410	SCALES KIT
11	546952	CYLINDER PROTECTION
13	37947	END MOTOR CAP
14	37948	CAPACITOR 8 MICRO-FARAD
15	537409	MOTOR FLANGE KIT (OUTER AND INNER)
16	546951	ARM SUPPORT ASSEMBLY
17	546946	HEAD RETURN SPRING
18	554651	SHIELD WHEEL PROTECTOR
19	105654	SHIELD KIT
20	109248	METAL SHIELD
21	108196A	LIGHT SOCKET E12 W/WIRES - 120V
22	105538	HANDLE KIT
24	546950	COMPLETE HYDRAULIC A.BLY

120V~ 60Hz

